



**RAM  
ON  
ESTE  
VE**  
STUDIO

Exclusive  
Designer  
Villa for sale  
in Benissa





Since 1993, DREIER NEW HOUSE has been creating dream homes on the Costa Blanca. With a passion for quality, each villa is a work of art, built with care and infused with the company's signature attention to detail.

The team at Dreier New House brings imagination to life, guiding clients on a journey from concept to creation, and always with a commitment to superb after-sales service.

















In 1991, Ramón Esteve founded the studio with the certainty that architecture was a global discipline.

"Since then, we have been building a professional team united by the search of a common objective, generating design solutions to unique spaces, objects and brands. Today, the studio is a place where architects, designers and creatives work together to develop signature projects."



*“Creativity is the result  
of imagining, solving  
and surprising.”*





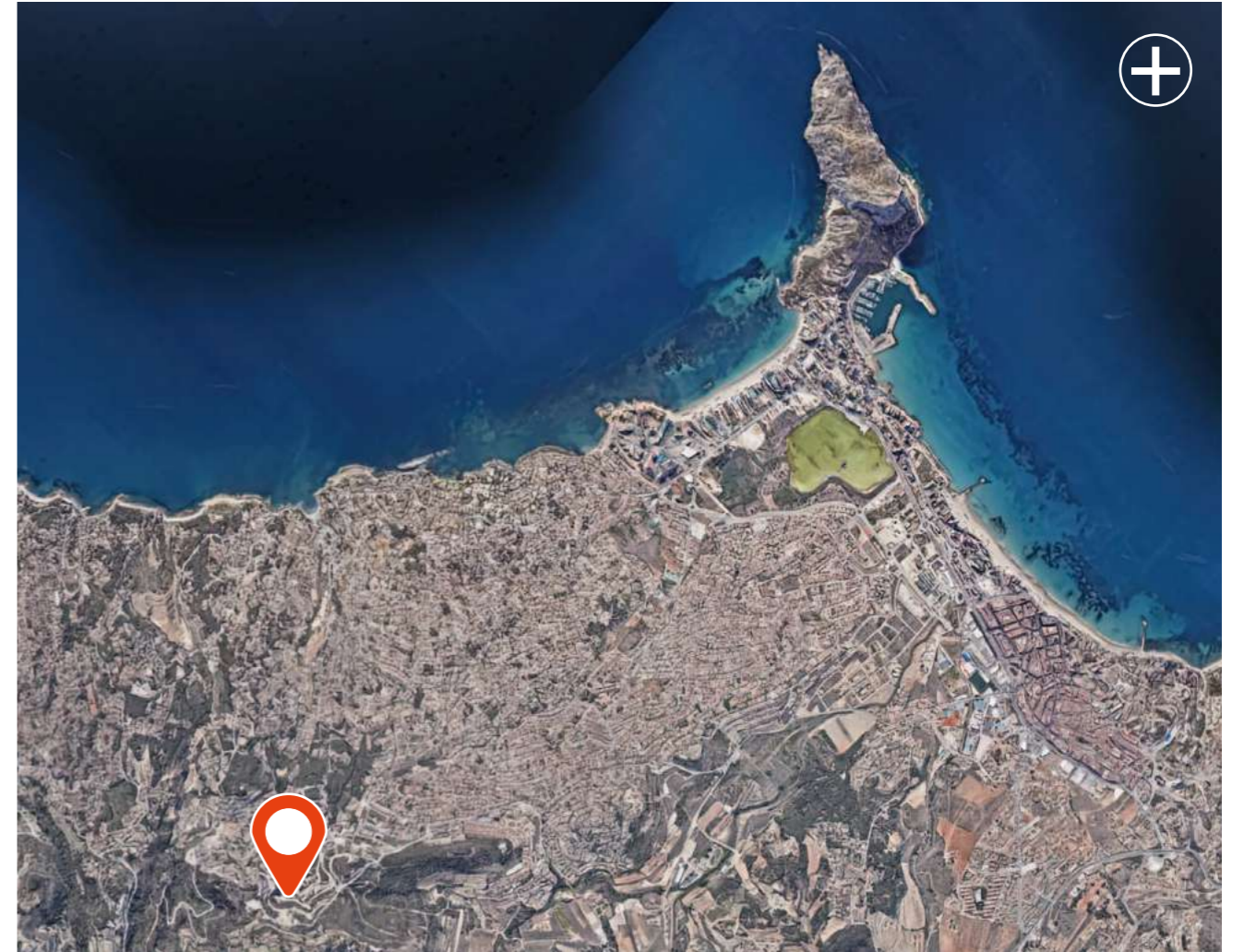

This villa is located in the exclusive Racó de Galeno area in Benissa (Alicante). This area is known for its luxurious villas and its privileged natural surroundings, offering stunning views of the Mediterranean Sea and the mountains.

Located approximately 2.5 kilometers from La Fustera Beach, a charming beach with fine sand and crystal-clear waters.

Also has easy access to main roads, allowing for quick travel to nearby towns such as Calpe and Moraira. It is also well connected to the AP-7 highway, facilitating access to the cities of Alicante and Valencia.









## General description

This cosy designer villa consists of 4 floors, all connected by an interior staircase and elevator.

On the basement floor you will find a very spacious garage with an easy access from the street and an access hall to the interior staircase and elevator that connects all 4 floors.

The next floor is the lower ground floor consisting of a huge multi-purpose area with window openings, which the future owner can develop as they please. This also offers the option to create up to 3 extra bedrooms with natural light entry.

On the ground floor, we have 1 bedroom with an en-suite bathroom, a guest toilet and a spacious living/dining room with a fully equipped kitchen with electrical appliances. The living room is provided with extra ceiling height, allowing the beautiful Mediterranean light to shine into the house.

Last but not least, on the first floor you will find 2 more full-sized bedrooms with en-suite bathrooms and a studio.

This spectacular villa has been designed considering the wonderful climate we have in this area and therefore is provided with very spacious terraces protected with porches in order to enjoy the full Mediterranean lifestyle.

- Plot: 1.573,00m<sup>2</sup>
- House: 770,10m<sup>2</sup>
- Terrace: 208,40m<sup>2</sup>
- Porch over terrace: 186,90m<sup>2</sup>
- Swimming Pool: 76,80m<sup>2</sup>.
- Orientation: South - East



Distribution plan  
Basement

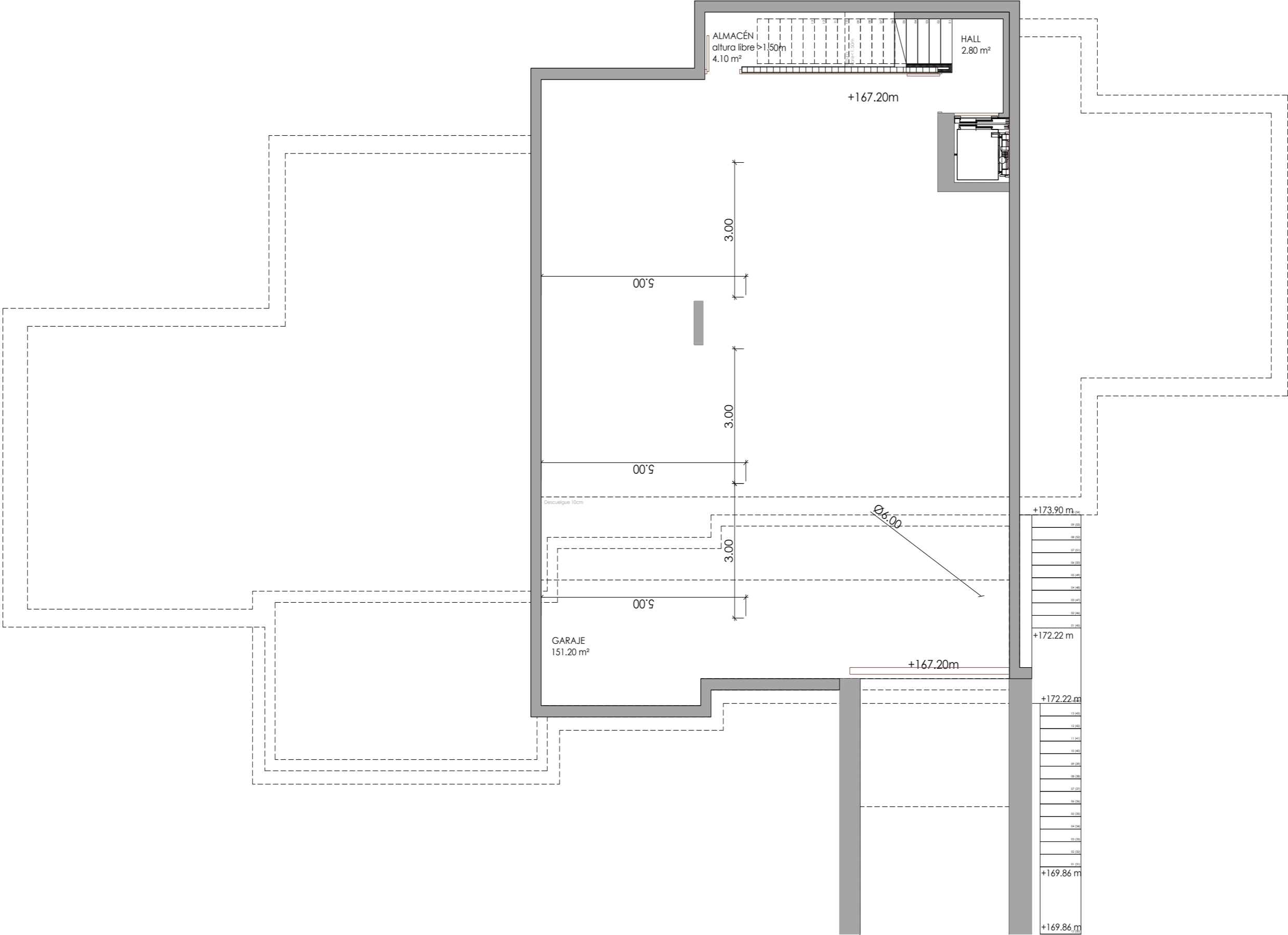



Distribution plan  
Lower ground floor

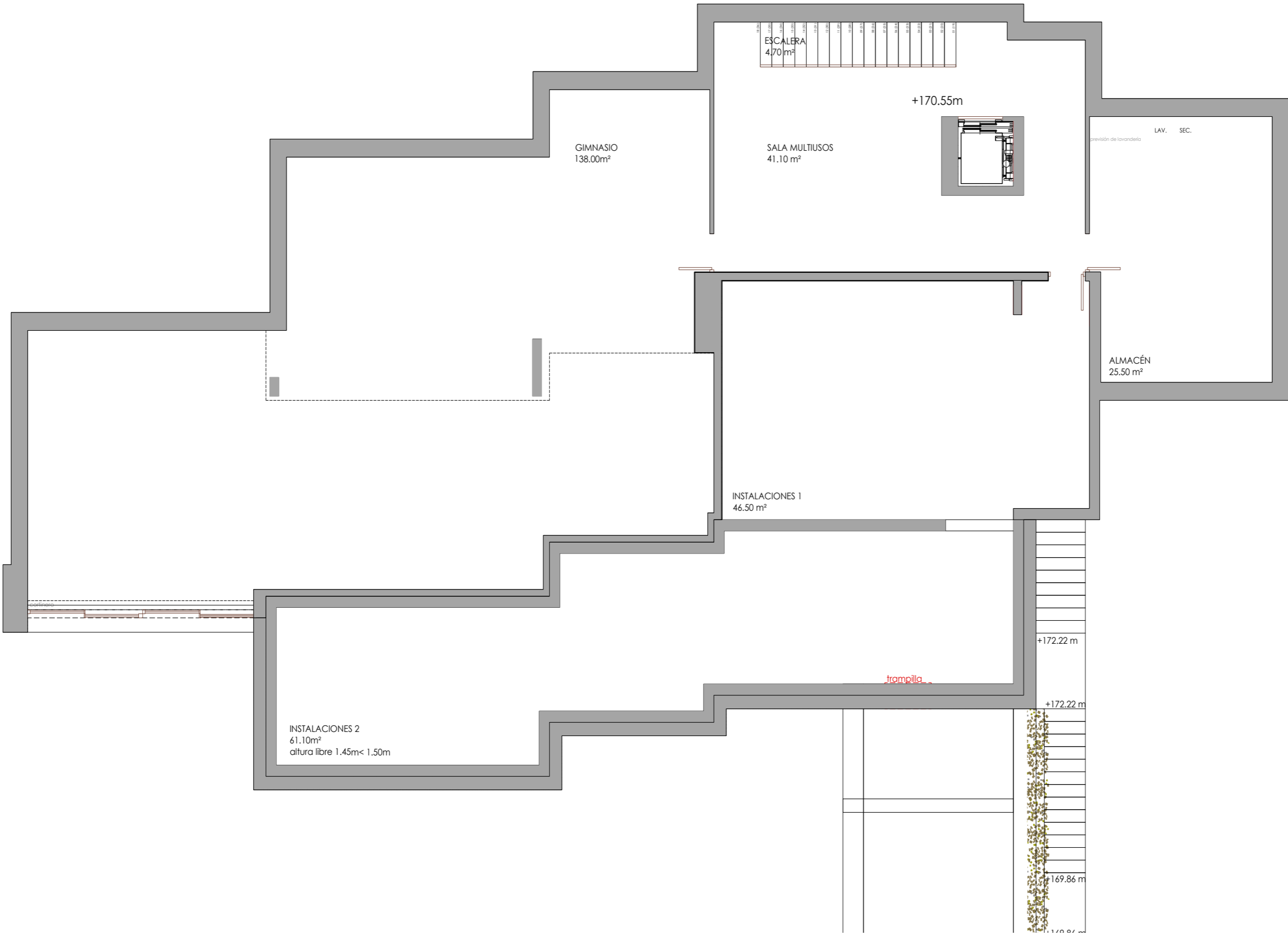



Distribution plan  
Ground floor

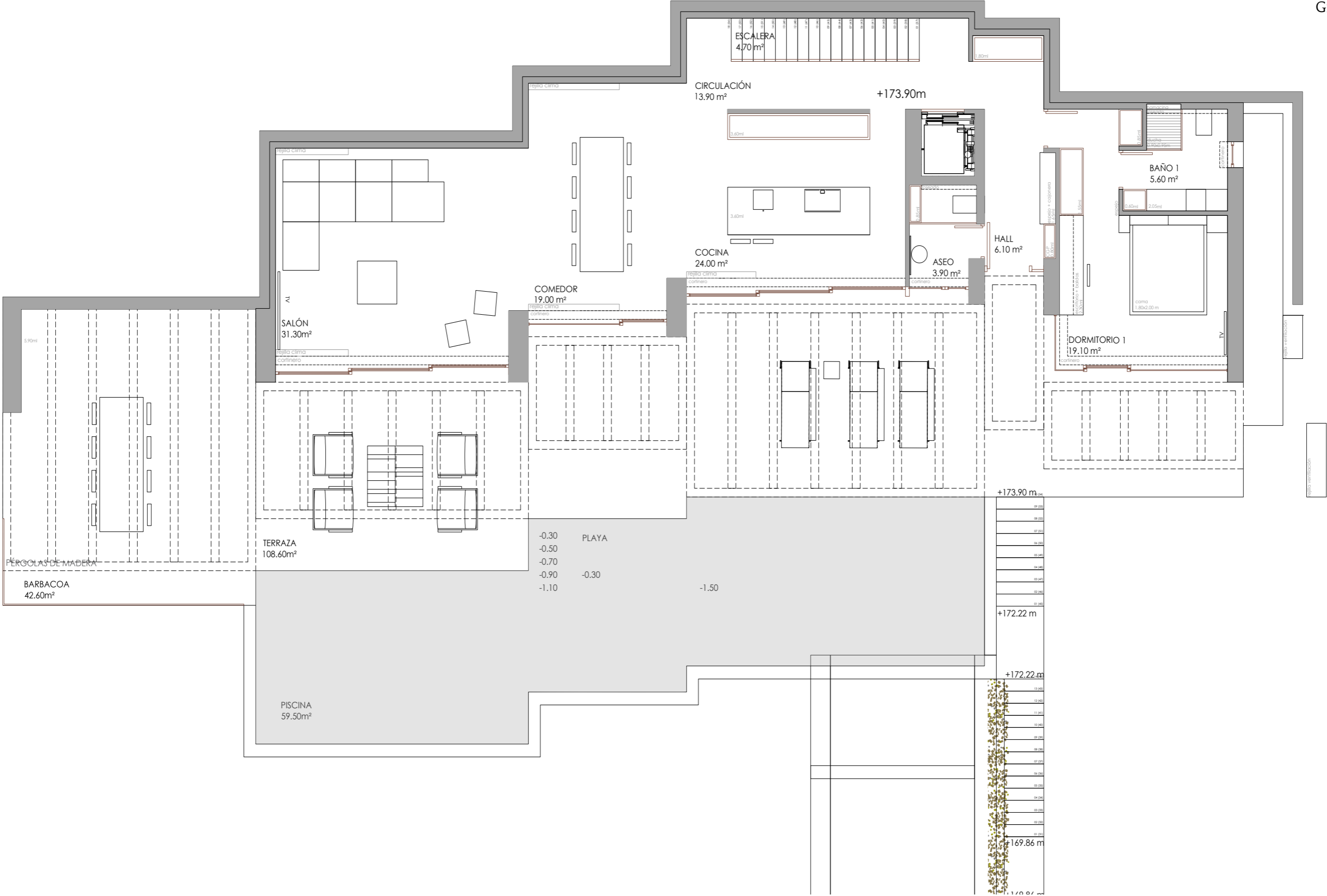



Distribution plan  
First Floor

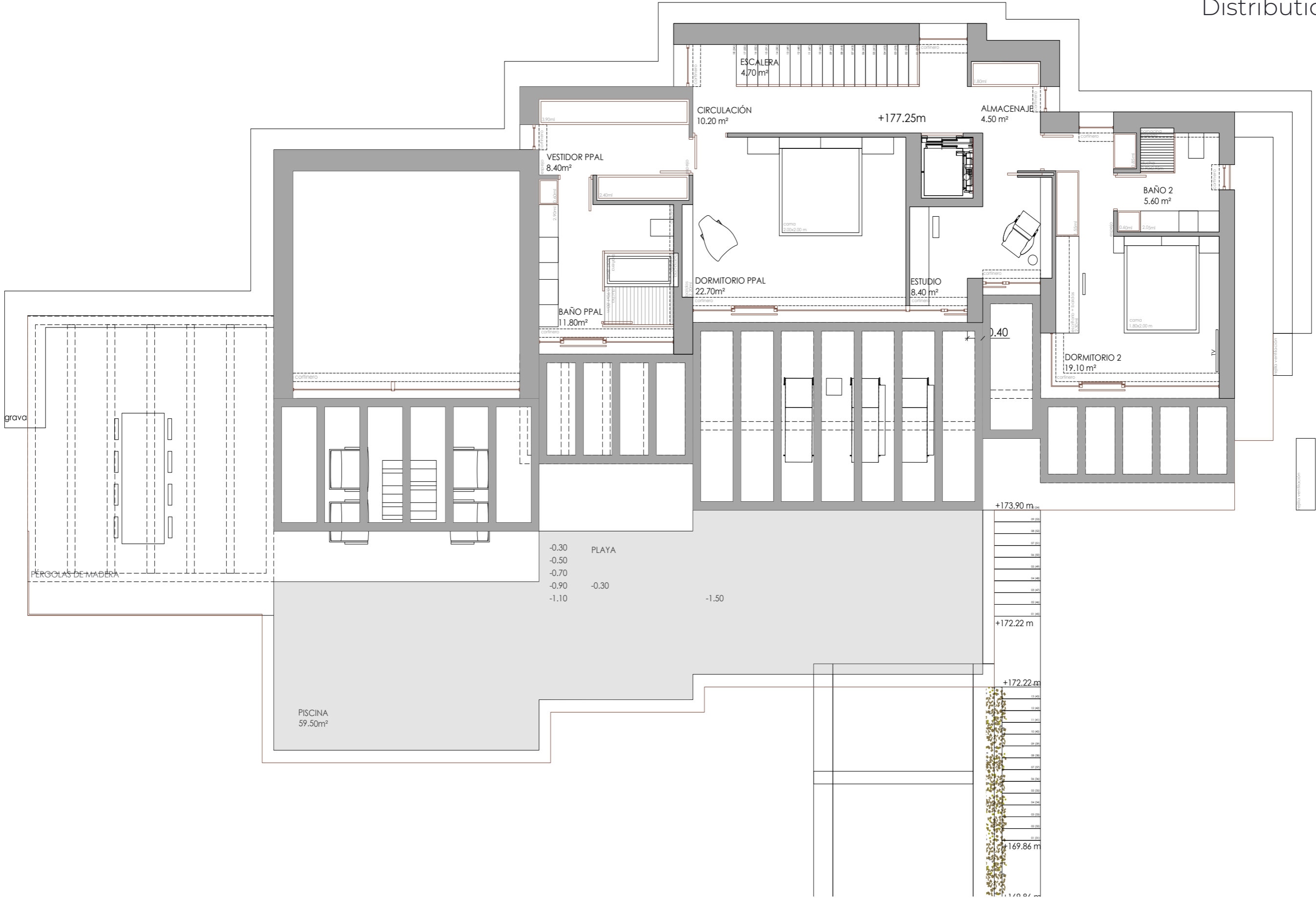





#### BASEMENT

- Storage - 4.10 m<sup>2</sup>
- Hall - 2.80 m<sup>2</sup>
- Garage - 151.20 m<sup>2</sup>

#### LOWER GROUND FLOOR

- Gym - 138 m<sup>2</sup>
- Multipurpose room - 41.10 m<sup>2</sup>
- Storeroom - 25.50 m<sup>2</sup>
- Facilities 1 - 46.50 m<sup>2</sup>
- Facilities 2 - 61.10 m<sup>2</sup>

#### GROUND FLOOR

- Hall 6.10 m<sup>2</sup>
- Kitchen - 24 m<sup>2</sup>
- Dining room - 19 m<sup>2</sup>
- Living room - 31.30 m<sup>2</sup>
- Guest toilet - 3.90 m<sup>2</sup>
- Bedroom 1 - 19.10 m<sup>2</sup>
- Bathroom on suite 1 - 5.60m<sup>2</sup>
- Terrace - 108.60 m<sup>2</sup>
- BBQ Area - 42.60 m<sup>2</sup>
- Swimming pool - 59.50 m<sup>2</sup>

#### FIRST FLOOR

- Master bedroom - 22.70 m<sup>2</sup>
- Master bathroom on suite - 11.80 m<sup>2</sup>
- Master dressing room - 8.40 m<sup>2</sup>
- Storage 4.50 m<sup>2</sup>
- Study - 8.40 m<sup>2</sup>
- Bedroom 2 - 19.10 m<sup>2</sup>
- Bathroom on suite 2 - 5.60 m<sup>2</sup>











## Exterior carpentry



Minimal aluminium exterior carpentry - Double glazing.

Functional standards are guaranteed by excellent acoustic and thermal insulation performance and perfect resistance to wear and tear caused by weathering.





#### INTERIOR DOORS

MDF lacquered from floor to ceiling. Colour to be defined.

- Isolation rubber.
- Hidden hinges.

#### ENTRANCE DOOR

Pivoting security entrance door, with external lining of laminated marine wood.

Dimensions 120x280cm. + Fixed glass 30cm wide



## Bathrooms material finishes



- 01- Floor C3 (100x100 cm.) & (300x100 cm.) ceramic tiling
- 02- Oak veneer for washbasin furniture and wall panelling.
- 03- Made-to-measure washbasin countertop in porcelain tile.
- 04- Ceiling-mounted washbasin mirror with integrated LED lighting in the side panels.
- 05- Water-repellent paint for walls.



## Bathrooms Fittings

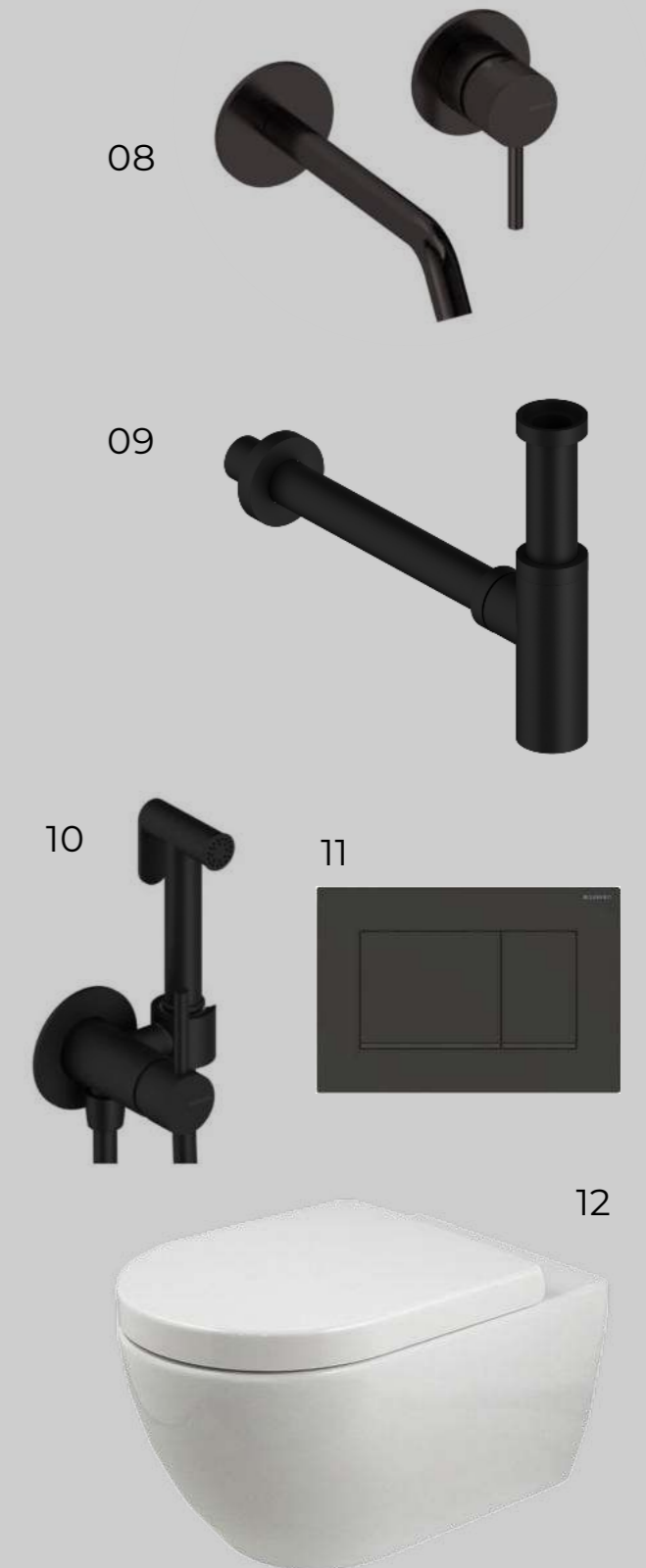
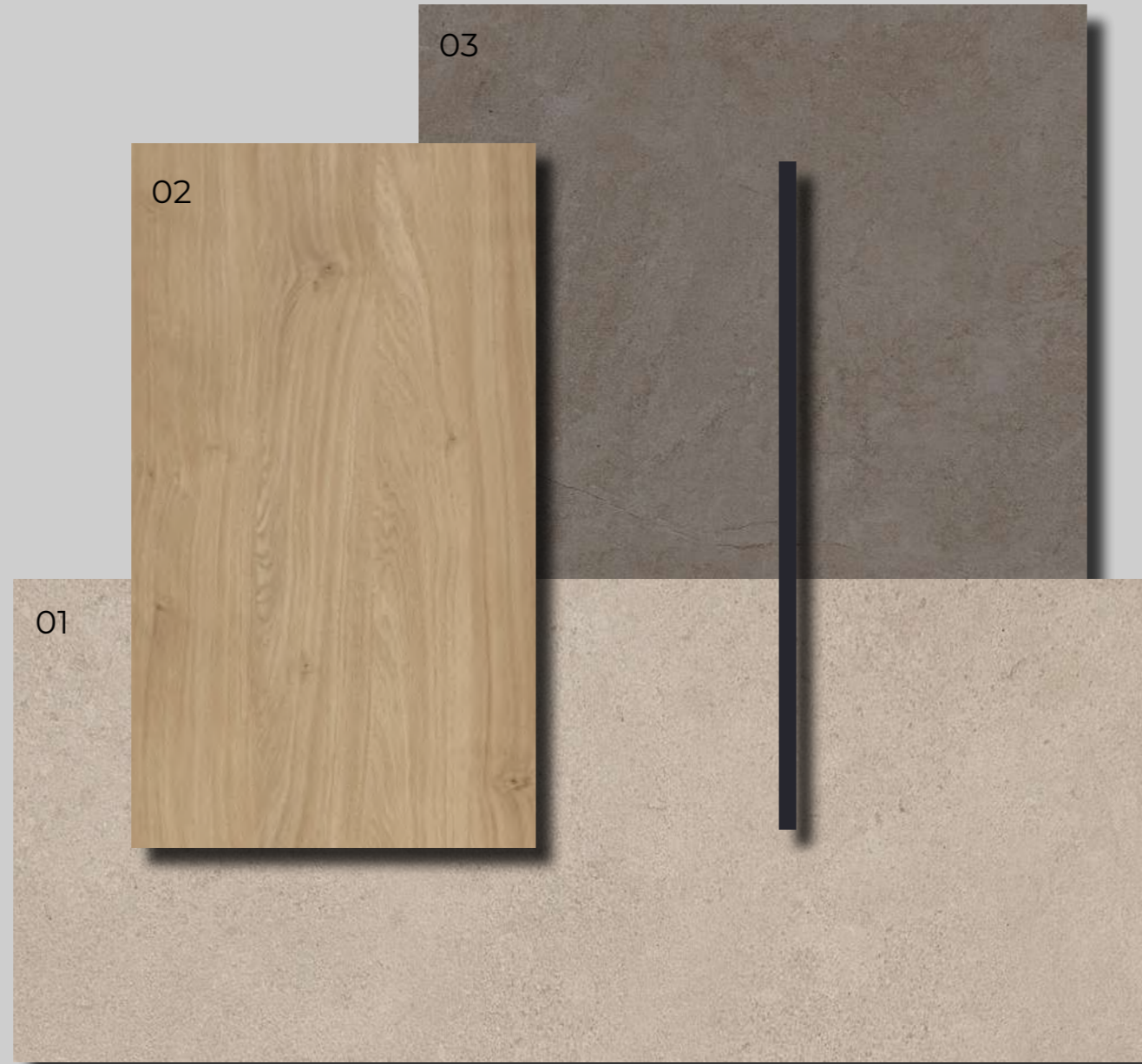
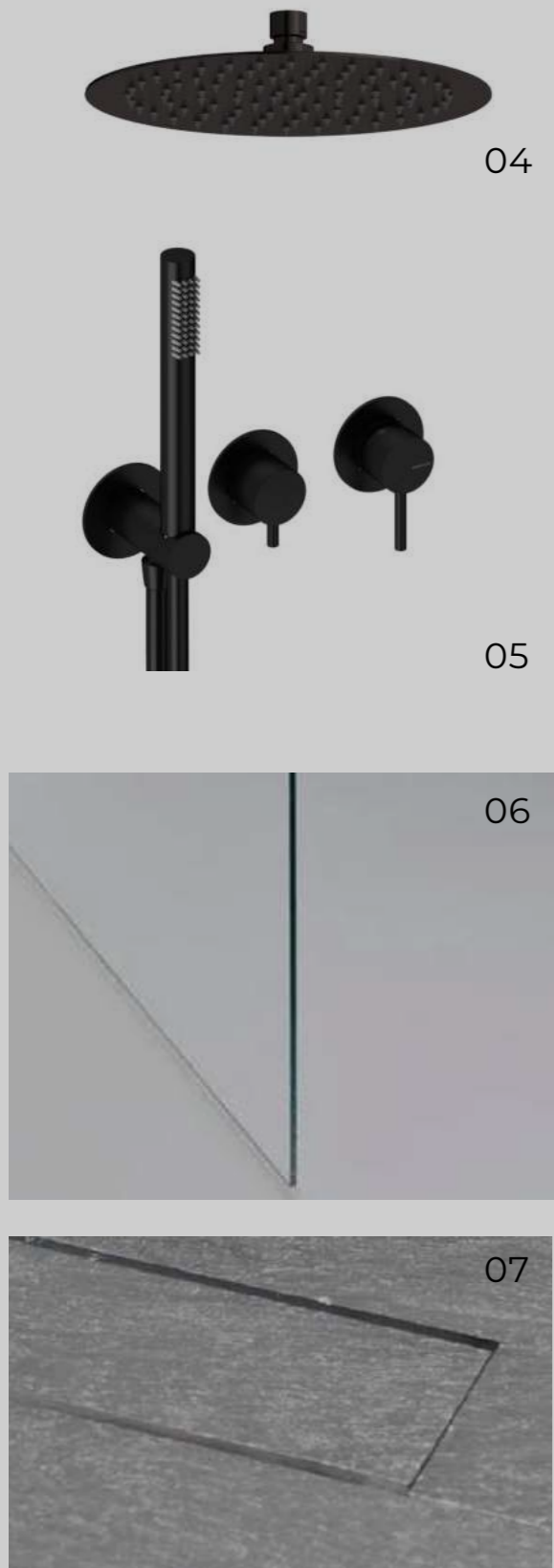

01- Floor C3 (100x100 cm.) & wall (300x100 cm.) ceramic tiling. 02- Oak veneered washbasin unit. 03- Made-to-measure washbasin countertop in porcelain tile. 04- Shower spray head. 05- Shower faucets, matt black. 06- Frameless shower enclosures with jandel. 07- Integrated shower grid. 08- Built-in basin taps, matt black. 09- Siphon for washbasin, matt black. 10- WC mixer tap, matt black. 11- Concealed cistern and push button, matt black. 12- Wc, white.



Kitchen

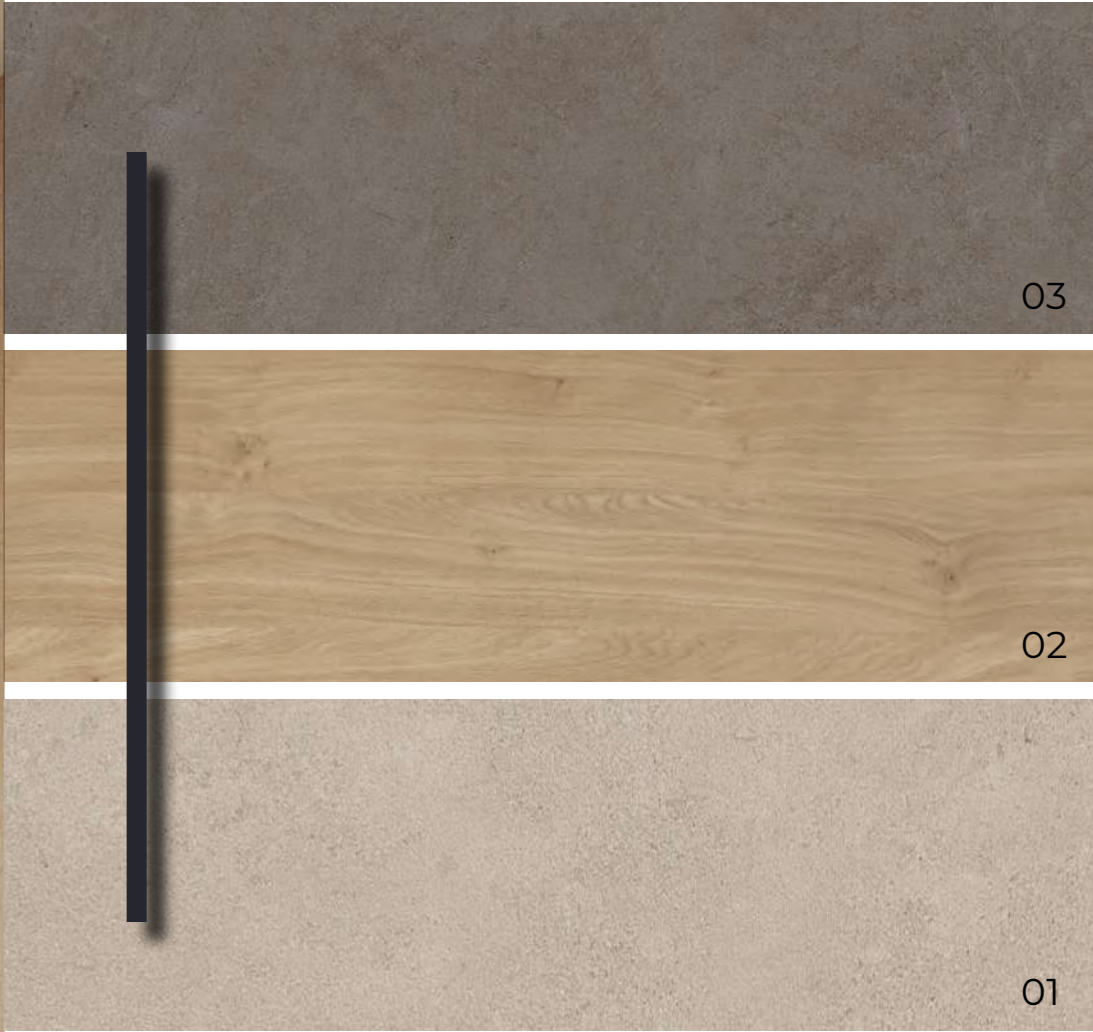

- 01- Floor (100x100 cm.) ceramic tiling.
- 02- Oak veneer for for kitchen island base units and 6 high storage units.
- 03- Made-to-measure ceramic countertop for kitchen island.
- 04- Paint for walls.



## Stairs

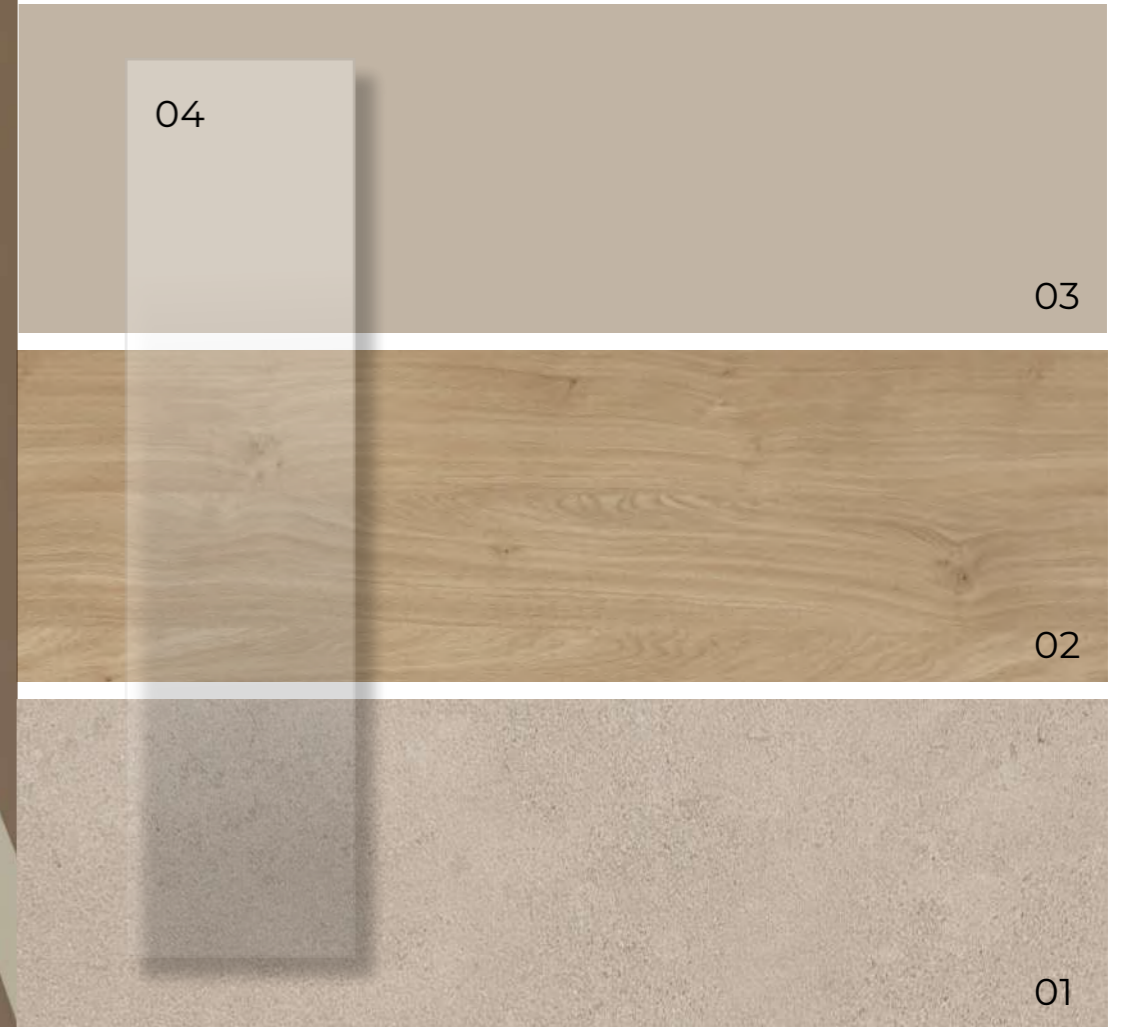

01- Floor (100x100 cm.) ceramic tiling.

02- Oak veneer Staircase from ground floor to first floor:  
Metallic structure with steps covered in wood veneer - darkened oak.  
Remaining staircase flights made of concrete and finished with the same ceramic material as used for the floor.

03- Paint for walls

04- Floor to ceiling glass railings.





















## Technical Equipment

- 1- PHOTOVOLTAIC SOLAR PANEL INSTALLATION.
- 2- DUCTED AIR-CONDITIONING SYSTEM.
- 3- UNDERFLOOR HEATING AND DOMESTIC HOT WATER VIA ELECTRIC HEAT PUMP (AEROTHERMIA).
- 4- AIR-TO-AIR HEAT EXCHANGE VENTILATION SYSTEM.
- 5- CONNECTED TO THE PUBLIC SEWAGE NETWORK.
- 6- WATER SOFTENER FOR DOMESTIC USE.







---

# DREIER

NEW HOUSE

\*The images and information shown in this dossier are merely representative and not binding.  
Construcciones y Mantenimiento Dreier S.L. keeps its right to make the appropriate modifications or adjustments in order to adequately carry out this project.

[www.dreiersl.com](http://www.dreiersl.com)

